

# Door / Door Operator Components for Otis

## 6940A door lock

Part Number	Otis Part Number	Description
ODO-67	B6940C2	Door lock assembly, L.H. as shown
ODO-68	B6940C1	Door lock assembly, R.H.
ODO-30	306FM1	Contact base
ODO-63	209E1	Roller bearing
ODO-18	320AY1	Bumper, polyurethane, 23.8 mm W, 38.1 mm L, 15.9 mm thick
ODO-16	320P4	Bumper, polyurethane, 38.1 mm D, 36.5 mm L
ODO-59	307AE1	Lever, bell crank, R.H.
ODO-60	307AE2, AE4	Lever, bell crank, L.H.
ODO-9	77A1	Eccentric pin
ODO-10	77A2	Eccentric pin
ODO-11	77A3	Eccentric pin
ODO-12	77A4	Eccentric pin
ODO-64	172DE9	Retaining ring, 15.9 mm (circlip)
ODO-17	456BT1	Roller, 25.4 mm D x 11.1 mm W
ODO-5	456C1	Skate roller, 41.3 mm L
ODO-6	456C2	Skate roller, 29.4 mm L
ODO-7	456C3	Skate roller, 32.5 mm L
ODO-8	456C4	Skate roller, 38.1 mm L
ODO-52	90HB9	Compression spring
ODO-50	92AG1	Torsion spring, 45.2 mm I.D., R.H.
ODO-53	A92AG1	Torsion spring, 49.2 mm I.D., R.H.
ODO-51	92AG2	Torsion spring, 45.2 mm I.D., L.H.
ODO-54	A92AG2	Torsion spring, 49.2 mm I.D., L.H.
ODO-65	127VB83	Washer, 38.1 mm O.D., 16.3 mm I.D., 1.2 mm thick
ODO-67A	A316CBA4, 316BJC2	Door lock base, L.H.
ODO-68A	A316CBA3, 316BJC1	Door lock base, R.H.

ODO-67

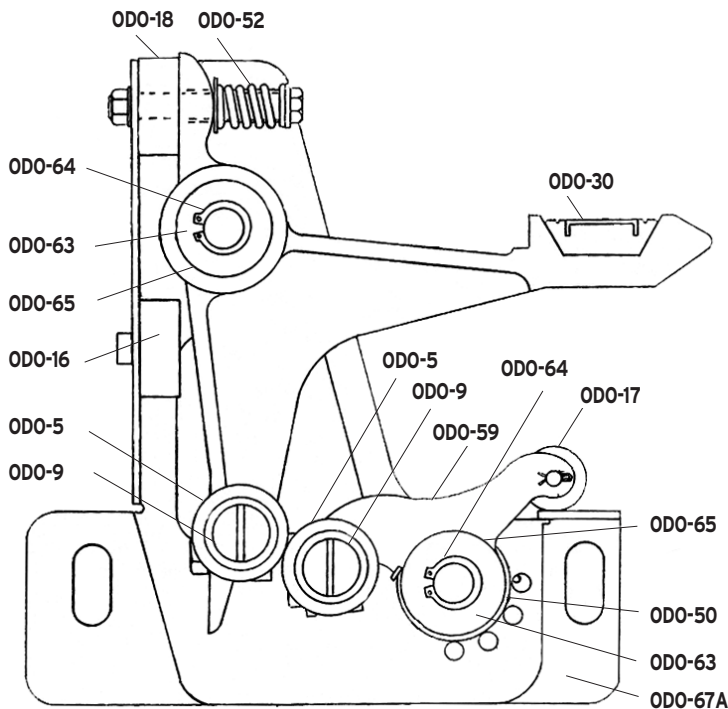
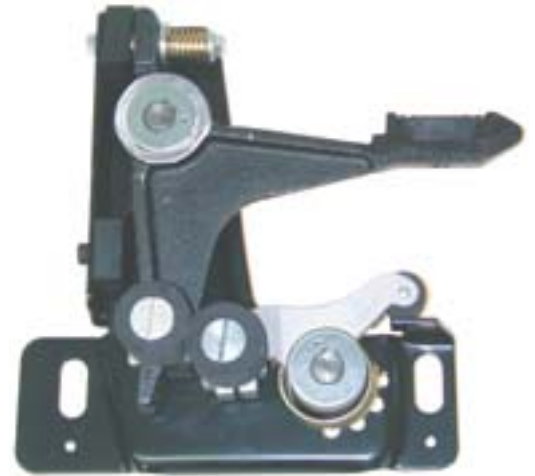

# Door / Door Operator Components for Otis

## Components for 6940A door lock

Part Number	Otis Part Number	Description
ODO-5	456C1	Skate roller, 41.3 mm L, rubber
ODO-5-P		Skate roller, 41.3 mm L, polyurethane
ODO-6	456C2	Skate roller, 29.4 mm L, rubber
ODO-6-P		Skate roller, 29.4 mm L, polyurethane
ODO-7	456C3	Skate roller, 32.5 mm L, rubber
ODO-7-P		Skate roller, 32.5 mm L, polyurethane
ODO-8	456C4	Skate roller, 38.1 mm L, rubber
ODO-8-P		Skate roller, 38.1 mm L, polyurethane
ODO-9	77A1	Eccentric pin, for ODO-5 and 5-P, 63.5 mm
ODO-10	77A2	Eccentric pin, for ODO-6 and 6-P, 56.4 mm
ODO-11	77A3	Eccentric pin, for ODO-7 and 7-P, 59.5 mm
ODO-12	77A4	Eccentric pin, for ODO-8 and 8-P, 65.9 mm
ODO-16	320P4	Bumper, polyurethane
ODO-18	320AY1	Bumper, polyurethane
ODO-20		Bumper, 25.4 mm dia. x 15.9 mm, stem 17.5 mm dia. x 14.3 mm
ODO-20A		Bumper, 25.4 mm dia. x 19.1 mm, stem 17.5 mm dia. x 15.9 mm
ODO-20B		Bumper, 31.8 mm dia, 25.4 mm L, 14 mm stem
ODO-17	456BT1	Roller, 25.4 mm dia. x 11.1 mm W
ODO-17A	78C2	Shaft, for ODO-17 roller
ODO-30	306FM1	Contact base
ODO-50	92AG1	Spring, R.H., 45.2 mm I.D.
ODO-51	92AG2	Spring, L.H., 45.2 mm I.D.
ODO-52	90HB9	Compression spring
ODO-53	A92AG1	Torsion spring, R.H.
ODO-54	A92AG2	Torsion spring, L.H.
ODO-59	307AE1	Bell crank lever, R.H. as shown
ODO-60	307AE2	Bell crank lever, L.H.
ODO-62		Sleeve, for roller bearing
ODO-63	209E1	Roller bearing
ODO-64	172DE9	Retaining ring, 15.9 mm (circlip)
ODO-65	127VB83	Washer, 38.1 mm O.D., 16.3 mm I.D., 1.2 mm
ODO-66	353Y1	Rubber coupler, for "O" operator

ODO-5



ODO-9



ODO-16



ODO-18



ODO-20



ODO-17



ODO-17A



ODO-30



ODO-50



ODO-52



ODO-53



ODO-59



ODO-62



ODO-63



ODO-64



ODO-65



ODO-66



# Door / Door Operator Components for Otis

## 6940AG interlock switch and components

Part Number	Otis Part Number	Description
ODO-31	6940AF1	Interlock switch, complete assembly for type 6940AG
ODO-32	306JJ1	Base, molded plastic for interlock switch, two required
ODO-33	152BE2	Contact, R.H. replacement for switch
ODO-34	152BE4	Contact, L.H. replacement for switch
ODO-57	6940AG1	Switch and housing, R.H., complete assembly includes ODO-31, 32, 33
ODO-58	6940AG2	Switch and housing, L.H., complete assembly includes ODO-31, 32, 34
ODO-84	339FH1	Switch clip, for ODO-31

## 6940B interlock switch and components

Part Number	Otis Part Number	Description
ODO-35	6940BCH49800	Interlock switch, for 6940B interlock assembly
ODO-35A		Interlock assembly, L.H., plastic cover
ODO-35B		Interlock assembly, R.H., plastic cover
ODO-35C	6940B3	Interlock assembly, R.H., switch and steel cover
ODO-35D	6940B4	Interlock assembly, L.H., switch and steel cover
ODO-35E	90LA3	Spring, 25.4 mm L x 7.1 mm I.D.
ODO-35G		Screw, for ODO-35
ODO-36	306FX1	Base for contacts
ODO-37	152AV2	Movable contact, for interlock switch
ODO-38	152AW2	Stationary contact, for interlock switch

ODO-35



ODO-35D



ODO-57



ODO-31

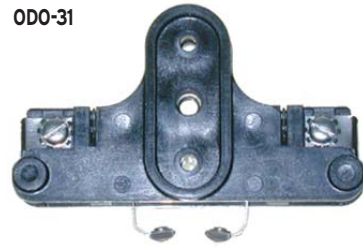

ODO-34



ODO-33



ODO-84



ODO-36



ODO-37



ODO-38



# Door / Door Operator Components for Otis

## 6098 switches

Part Number	Otis Part Number	Description
OHE-9	A6098A1	Floor stop switch, SPDT with auxiliary contacts, with arm A287E2
OHE-10	A6098A3	Floor stop switch, DPST, with auxiliary contacts, L.H. make, with arm A287E2
OHE-11	A6098A4	Floor stop switch, DPST, with auxiliary contacts, R.H. make, with arm A287E2
ODO-39	A287E2	Arm with roller, straight long arm, 133 mm, shown on OHE-9
ODO-41	287BA4	Arm with roller, short arm, 76.2 mm, shown on OHE-12
OHE-12	A6098B1	Limit switch, SPM with arm ODO-41B (287F4)
OHE-13	A6098B3	Limit switch, SPB with arm ODO-41A (287F4)
OHE-13A	A6098B11	Limit switch, SPB with arm ODO-40 (287F6)
OHE-14	A6098B5	Limit switch, DPM with arm ODO-41B (287F4)
OHE-14A	A6098B15	Limit switch, DPM with arm ODO-41C (287F8)
ODO-41A	287F2	Arm with roller, 133 mm, L.H.
ODO-40	287F6	Arm with roller, 133 mm, R.H.
ODO-41B	287F4	Arm with roller, 133 mm, L.H., mounting holes 10 degrees off center
ODO-41C	287F8	Arm with roller, 133 mm, R.H., mounting holes 10 degrees off center
ODO-41D	456BY1	Roller, 41.3 mm dia. with nylon bushing, 60 durometer polyurethane to replace sponge rubber type
ODO-41E	456AA2	Roller, 31.8 mm dia. with bushing, 60 durometer polyurethane
OHE-15	6098D1	Tripper switch, SPB, hand as shown
OHE-16	6098D3	Tripper switch, SPB, hand opposite
OHE-17	6098E1	Gate switch, SPM, hand as shown
OHE-18	6098E2	Gate switch, SPM, hand opposite
OHE-19	6098E5	Gate switch, DPM, hand as shown
OHE-20	6098E6	Gate switch, DPM, hand opposite

OHE-9



OHE-12



ODO-39



ODO-40



ODO-41



ODO-41A



ODO-41B



ODO-41C



OHE-17, OHE-19



OHE-15



ODO-41E



# Door / Door Operator Components for Otis

## Keys, escutcheons and gibs

Part Number	Otis Part Number	Description
ODO-45	194AD2	Lunar key, emergency hoistway, 267 mm
ODO-46	194AD7	Key, double drop door key
MIS-210	320CX1	Bumper, rubber collar for keys
ODO-46A	194AD3	Key, single joint door key
ODO-73	321CV1	Escutcheon, door sleeve, stainless steel, 70 mm
ODO-73A	321CV5	Escutcheon, door sleeve, brass, 70 mm
ODO-73B	386TZ13	Escutcheon, lunar key, nickel finish, 40.1 mm L
ODO-73C		Escutcheon, lunar key, brass finish, 40.1 mm L
ODO-46B	194AD6	Key, close couple key
ODO-76	443J4	Key box glass, replacement, 289 mm x 41 mm x 1.6 mm
ODO-3	288LV1	Lever, hoistway door
ODO-70	2220D16	Door gib complete, 203 mm
ODO-71	2213R1	Door gib complete, 159 mm
ODO-71A	251BJ1	Gib insert, 76.2 mm, for ODO-70 and ODO-71
ODO-71D	456DD1	Gib roller
ODO-72	VP869750	Gib, 12.7 mm offset nylon door guide, includes WDO-59, replaces spring loaded door guide
WDO-59	237GAN	Gib insert, for ODO-72 assembly, 101.6 mm L

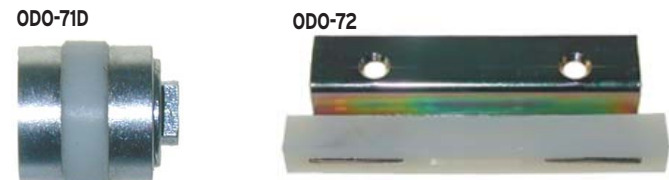

# Door / Door Operator Components for Otis

## Guides, sprockets, switches and bearings

Part Number	Otis Part Number	Description
ODO-77	237AR2	Door guide, 114 mm L, for vertical gates
ODO-79	380BS2	Guide shoe insert, LRV
ODO-79A	380BV2	Guide shoe insert, 152 mm, LRV
ODO-25	A332AS2	Chain with hitch and link, for 6940D spring door closer, 286 mm L
ODO-26	A332AS3	Chain with hitch and link, for 6940D spring door closer, 362 mm L
ODO-42	132037	Base, for 'L' and 'LA' door lock contact (mounted with ODO-43 OR ODO-44)
ODO-43	147976	Contact holder, for 'L' door lock
ODO-44	156144	Contact holder, for 'LA' door lock
ODO-27	195FK1	Sprocket, for 7300A operator, 10 teeth, 12.7 mm pitch, 46.7 mm O.D., 15.9 mm bore for 40ASA roller chain
ODO-27A	195CP2	Sprocket, for 30S operator, 9 teeth, 31.8 mm O.D. x 19.1 mm wide, 9.5 mm I.D.
ODO-27B	195GK2	Sprocket, 15.9 mm I.D. with 10 teeth
ODO-49	327DJ2C	Cam and clamp assembly, for power door operator switches and 6850 selector
ODO-48	A306EB2	Interlock switch base, with formed leaf spring contact, two required, used on N and NC style interlocks
ODO-28	125021	Bearing and seal kit, for 6970A door operator
ODO-29	125022	Bearing and seal kit, for 7300A door operator

ODO-77



ODO-79



ODO-79A



ODO-25, ODO-26



ODO-27



ODO-27A



## Miscellaneous door components

Part Number	Otis Part Number	Description
ODO-12A	165D1	Quadrant arm and seal, for 7300A operator
ODO-78	332BC2	Chain assembly, with studs for 7300 door operator
ODO-47	320BE2	Bumper roller, for chain of 7300 door operator, polyurethane
ODO-12B	442AL1, 2	Piston, for 7300A operator
ODO-12C	288LK1	Arm lever, for 7300A door operator
ODO-1A	177AR1	Microswitch, for safety edge
ODO-4	125028	Aircord hitch

ODO-12A



ODO-78



ODO-12B



ODO-47



ODO-4



ODO-12C



ODO-49



ODO-48



ODO-28



ODO-42



ODO-43



ODO-44



ODO-1A

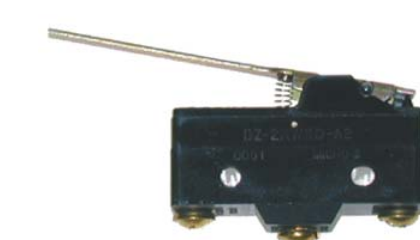

# Door / Door Operator Components for Otis

## Motors, cables and spirators

Part Number	Otis Part Number	Description
ODO-61	A325P1	Polyurethane cup, for M.L. A6940AD1 to AD3 door closer
ODO-80	74358	Chain hitch assembly, O operator
ODO-66	353Y1	Rubber coupler, O operator
ODO-81	265BD3	Sheave and guard, for relating cable
ODO-81A	B316CCB2	Sheave and bracket assembly
ODO-82	YYLO174HH1	Cable, 3.6 metres, memcor door detector
ODO-83	YYLO174HH2	Cable, 6.1 metres, memcor door detector
ODO-55	6554B1	Mechanical switch, "make" for 6970A door operator
ODO-56	6554B2	Mechanical switch, "break" for 6970A door operator
ODO-74	299ADP2	Spirator bracket
ODO-74A	316DER2	Spirator bracket, w/offset
MIS-124	6940AR1	Spirator, reel closer
ODO-19	6168F1	Door check, with air flow adjusting for 6993 safety shoe
ODO-19A	6168F5	Air check valve, new type
ODO-75	6333AJ1 6333AL1	Door motor, 115-230VDC, 1/2 HP, 12.7 mm shaft, 3.2 mm key
ODO-75A	6333BX1	Door motor, 220V, 60 cycle, 90 RPM
ODO-75B	6333AM1	Door motor, 2.7 N/metres, 220V, 3 phase
ODO-75C	6333CC2	Door motor/gear assembly, 90 VDC, 69 RPM, 21.9 kg/m torque
ODO-75C-A		Brush cap, for ODO-75C
ODO-75D	6333CC1	Door motor, 90v, 100-110 RPM, 21.9 kg/m torque
OCB-42	240BA1	Carbon brush, 12.7 mm thick., x 6.4 mm W x 19.1 mm L ODO-75D (6333CC1), ODO-75C (6333CC2)

ODO-19



ODO-19A



ODO-61



ODO-81



ODO-81A



ODO-80



ODO-55

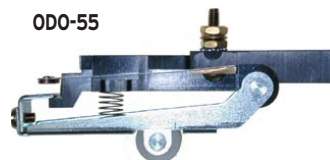

ODO-66



ODO-74



MIS-124



ODO-75



ODO-75C-A



ODO-75B



ODO-75C



# Door / Door Operator Components for Otis

## Uphrust rollers

Part Number	Otis Part Number	Description	Spacing
ODO-13	456CP1	Uphrust roller, 35 mm dia. x 13 mm	13 mm
ODO-14	456CP2	Uphrust roller, 35 mm dia. x 13 mm	6.4 mm
ODO-15	207Z4	Uphrust roller, 35 mm dia. x 11 mm	3.2 mm
ODO-15A	456Z1	Uphrust roller, 19 mm dia. x 11 mm	6.4 mm

## Springs

Part Number	Otis Part Number	Dimensions Diameter x Length	Coils	Wire Diameter
ODO-23	91W5	34.9 mm x 298 mm	60	3.8 mm
ODO-24	91AE1	38.1 mm x 306 mm	51	4.7 mm
ODO-24A	91W1	65.9 mm x 371 mm	30	8.4 mm
ODO-24C	91W2	34.9 mm x 273 mm	64	3.2 mm
ODO-21	91T8	41.3 mm x 229 mm	31	3.2 mm
ODO-22	91T9	42.9 mm x 171 mm	18	4.7 mm
ODO-22A	91T10	43.7 mm x 191 mm	19	5.5 mm
ODO-22B	91T11	61.9 mm x 203 mm	16-1/2	7.9 mm
ODO-22C	91T4	46.8 mm x 157 mm	12	5.7 mm
ODO-22D	91T5	47.6 mm x 184 mm	16	6.4 mm
ODO-22E	91T7	47.6 mm x 178 mm	14	6.4 mm
ODO-22F	91T12	57.9 mm x 192 mm	17	7.1 mm
ODO-24B	91T1	54.0 mm x 273 mm	28	6.4 mm

## Silicone shunts

Part Number	Otis Part Number	Dimensions Length	Hole I.D.
OSS-1A	175J88	95 mm	4.9 mm
OSS-2A	175J89	121 mm	4.9 mm
OSS-3A	175J90	146 mm	4.9 mm
OSS-4A	175J122	194 mm	4.9 mm

## Braided shunts

Part Number	Otis Part Number	Dimensions Length	Hole I.D.s	Thickness	Width
OBS-1	176AK1	171 mm	9.9/9.9 mm	2.4 mm	19 mm
OBS-2	176KA4	178 mm	6.7/9.9 mm	2.4 mm	13 mm
OBS-3	176KA6	203 mm	6.7/9.9 mm	0.8 mm	19 mm
OBS-4	176KA8	248 mm	6.7/6.7 mm	2.4 mm	19 mm
OBS-5	176KA13	162 mm	5.2/6.7 mm	0.8 mm	13 mm
OBS-6	176KA14	162 mm	9.9/6.7 mm	2.4 mm	13 mm
OBS-7	176KA3	343 mm	8.3/8.3 mm	2.4 mm	19 mm
OBS-8	176KA10	178 mm	6.7/6.7 mm	2.4 mm	13 mm

OBS-1 thru OBS-8



OL-8



## Cable and connectors

Part Number	Otis Part Number	Description
OL-1	112926	Triple cable, with 2 leads, 330 mm
OL-2		Cable, 260 mm L
OL-3	106594	Cable, 279 mm L, mounting holes c/c 260 mm
OL-5	104148	Double cable, 572 mm L
OL-5A	142741	Cable, 406 mm L
OL-6		Double cable
OL-7	263	Cable, 387 mm L
OL-8	175	Braided connector, 216 mm L x 25.4 mm W
OL-9	118	Braided connector, 114 mm L x 12.7 mm W
OL-10	175H1	Braided connector, 210 mm L

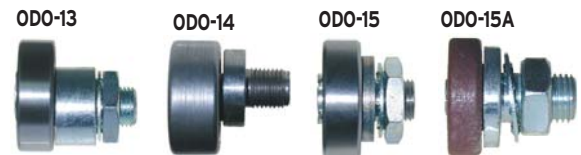

ODO-23, 24, 24A, 24C



ODO-21, 22, 22A-F, 24B



OSS-1A



OL-2



OL-5



OL-6



OL-7



# Door / Door Operator Components

## Detector shields and safety edge parts for Otis

### Shape 50ACV

Part Number	Otis Part Number	Description
ODS-1	278BG2, 278BG3 278BG10, 278BG11	Shield, hoistway door shield, L.H./R.H., 2.13 metres L
ODS-2	147CX3	Shield, hoistway door shield, B=1-1/2", C=1-3/16"
ODS-3		Shield, hoistway door shield, B=1-3/4", C=1-1/4"

Shape 50ACV

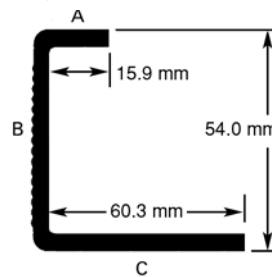

### Shape 50ADD female

Part Number	Otis Part Number	Description
ODS-4	147EW1, 147FC1	Shield, door faceplate, 2.13 metres L
	147EW2, 147FC2	Shield, L.H./R.H. door faceplate, 2.13 metres L

Shape 50ADD female

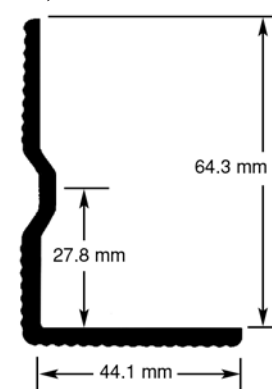

Shape 50ADC male

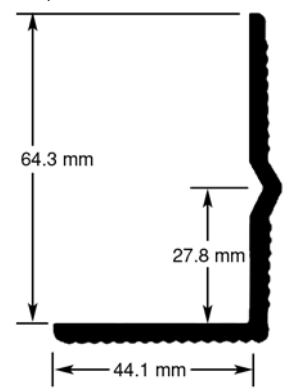

### Shape 50ADC male

Part Number	Otis Part Number	Description
ODS-5	147EY1, 147FB1	Shield, car door faceplate, 2.13 metres L, L.H./R.H.

### Shape A50DD female

Part Number	Otis Part Number	Description
ODS-6	A147EW1, A147FC1 A147EW2, A147FC2	Shield, car door faceplate, 2.13 metres L, L.H. / R.H.

Shape A50DD female

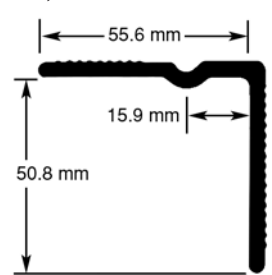

Shape A50ADC male

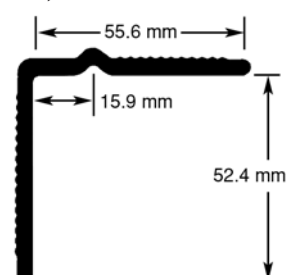

### Shape A50ADC male

Part Number	Otis Part Number	Description
ODS-7	A147EY1, A147FB1	Shield, door faceplate 2.13 metres L, L.H./R.H.

### Shape 50AFE female

Part Number	Otis Part Number	Description
ODS-8	147JX2, B147JX6, B147JW3	Shield, faceplate, 2.13 metres L, L.H./R.H.

Shape 50AFE female

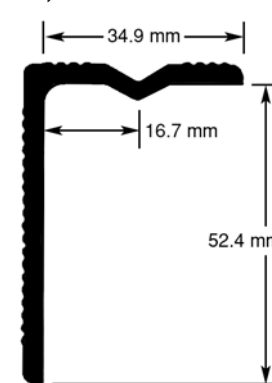

Shape 50AFF male

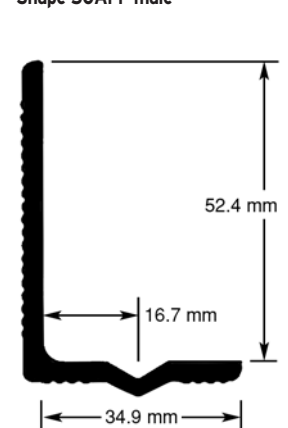

### Shape 50AFF male

Part Number	Otis Part Number	Description
ODS-9	147JV1, 147JW1 B147JV3, B147JW3	Shield, faceplate, 2.13 metres L, L.H./R.H.

Shields are not pre-drilled to enable the installer to match job requirements.  
Made of impact-resistant butyrate for durability.

### Safety edge microswitch and boot

Part Number	Otis Part Number	Description
ODO-1A	177AR1	Microswitch, for safe edge
OSE-1	A62381A1 & A2 B6218A1 & A2	Replacement boot, for safety edges 127 mm W x 2.11 m L
OSE-2	6993D1 & D2	Replacement boot, for safety edges, 82.6 mm W x 2.11 m L

OSE-1, OSE-2

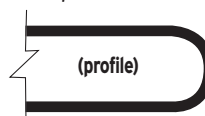

ODO-1A

